

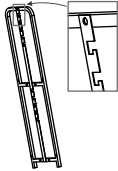

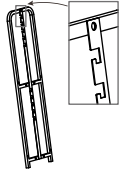







Instructions for LED Grow Light Garden Kit - 02

PART LIST

<p>A</p>  <p>A Side Frame (X1)</p>	<p>B</p>  <p>B Side Frame (X1)</p>	<p>C</p>  <p>Cross Bar (X9)</p>	<p>D</p>  <p>Hex Screws (X18)</p>	<p>E</p>  <p>Swivel Castors with Brakes (X2)</p>	<p>F</p>  <p>Swivel Castors (X2)</p>
<p>G</p>  <p>Hex Key (X1)</p>	<p>H</p>  <p>Open Ended Wrench (X1)</p>	<p>I</p>  <p>LED Fixtures (X2)</p>	<p>J</p>  <p>T-Type Power Cord (X1)</p>	<p>K</p>  <p>Zip Ties (X2)</p>	

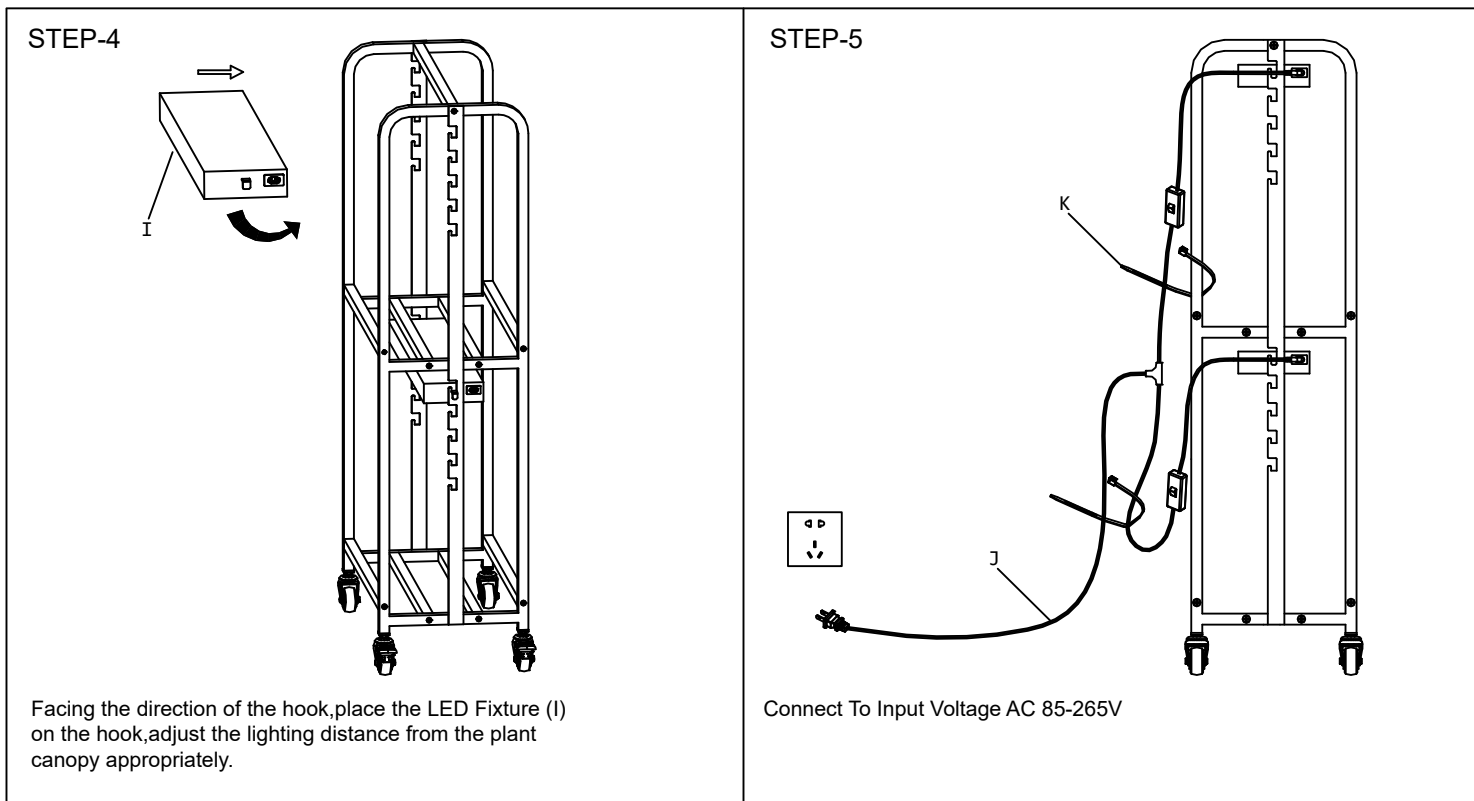
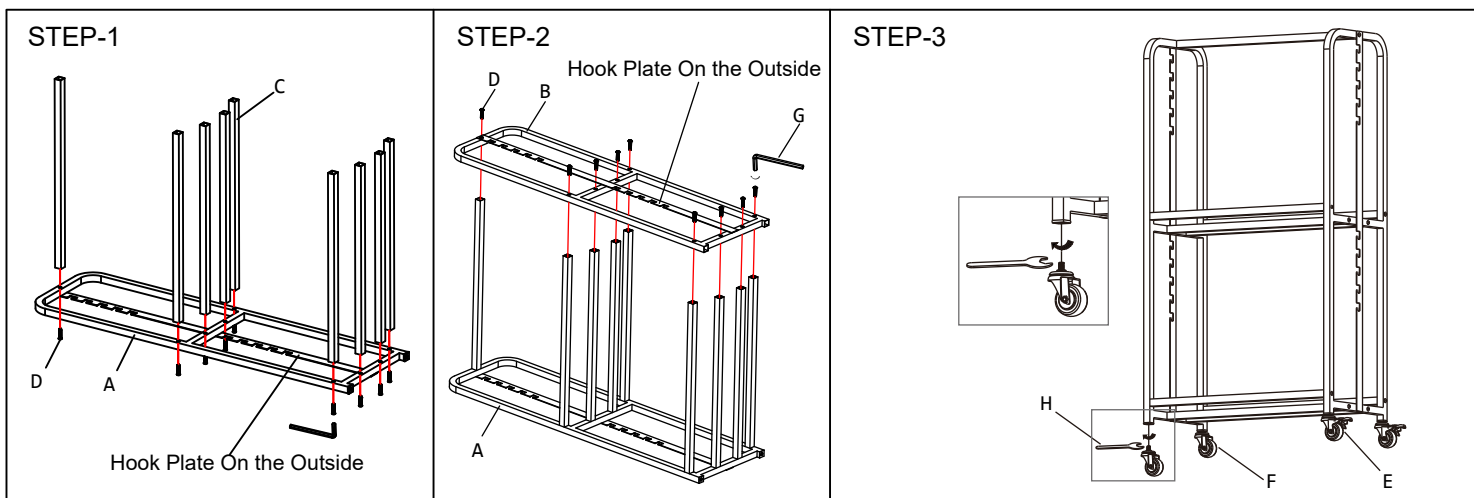

Warning

- Do not spray water directly onto LED Fixture.
- Turn off the power and unplug fixture before you perform any maintenance or cleaning.
- Avoid prolonged exposure and looking directly at light source.