

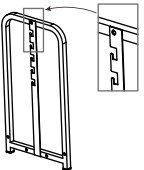

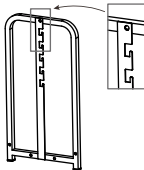



Instructions for LED Grow Light Garden Kit - 01

PART LIST

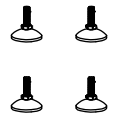
<p>A</p>  <p>A Side Frame (X1)</p>	<p>B</p>  <p>B Side Frame (X1)</p>	<p>C</p>  <p>Cross Bar (X5)</p>	<p>D</p>  <p>Hex Screws (X10)</p>	<p>E</p>  <p>Leveling Foot (X4)</p>
<p>F</p>  <p>Hex Key (X1)</p>	<p>G</p>  <p>LED Fixture (X1)</p>	<p>H</p>  <p>Power Cord (X1)</p>	<p>I</p>  <p>Zip Ties (X2)</p>	

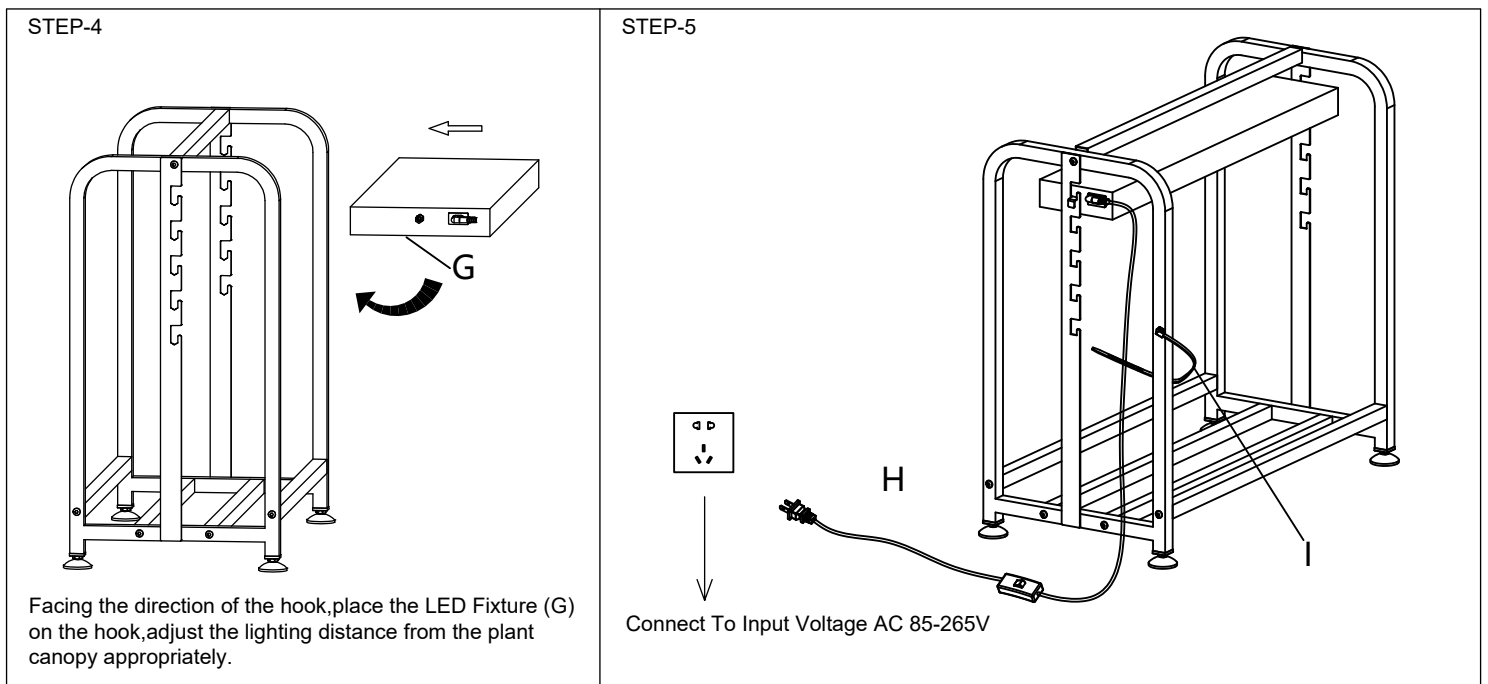
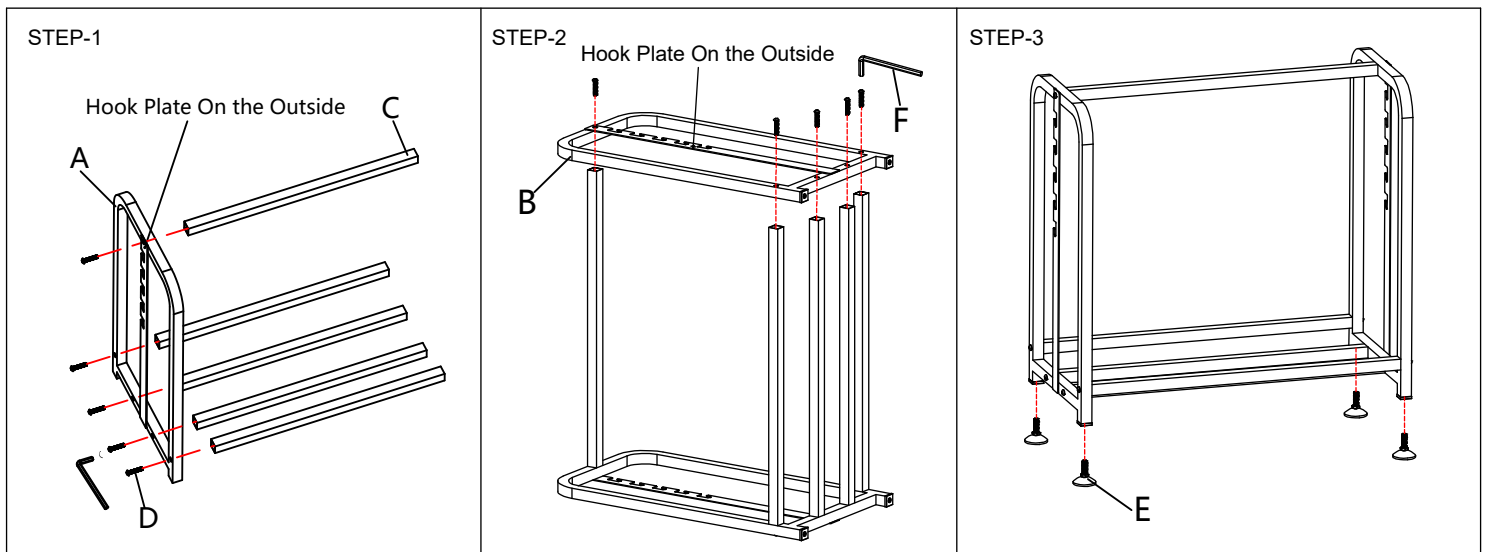

Warning

- Do not spray water directly onto LED Fixture.
- Turn off the power and unplug fixture before you perform any maintenance or cleaning.
- Avoid prolonged exposure and looking directly at light source.